



***LEUPOLD***

**BALLISTICS AIMING  
SYSTEM**

# Table of Contents

Boone and Crockett™ Big Game Reticle .....	Page 1
Varmint Hunter's™ Reticle .....	Page 11
LR Duplex® Reticle .....	Page 22
LRV Duplex® Reticle .....	Page 29
SAbot Ballistics Reticle (SA.B.R.®) .....	Page 34
Ballistic FireDot® Reticle .....	Page 44
Multi-FireDot™ Reticle .....	Page 51
Pig-Plex Ballistic Reticle .....	Page 59
TMOA™ Reticles .....	Page 64

**Various language translations of the BAS Manual can be found at [www.leupold.com](http://www.leupold.com).**

La traduction en français du manuel BAS se trouve à [www.leupold.com](http://www.leupold.com).

La traducción al español del manual BAS se encuentra en [www.leupold.com](http://www.leupold.com).

Das BAS-Handbuch in deutscher Sprache finden Sie unter [www.leupold.com](http://www.leupold.com).

La traduzione in italiano del manuale BAS è pubblicata sul sito seguente: [www.leupold.com](http://www.leupold.com).

# The Leupold Ballistics Aiming System<sup>®</sup>— Boone and Crockett<sup>™</sup> Big Game Reticle

The goal of every hunter is a successful hunt with a clean harvest. It was with this in mind that Leupold<sup>®</sup> created the Leupold Ballistics Aiming System<sup>®</sup>. Because we so strongly agree with the Boone and Crockett Club's legacy of wildlife conservation and ethical fair chase hunting, we have designated one of the system's reticles as the Boone and Crockett<sup>™</sup> Big Game reticle.

The Boone and Crockett Big Game reticle gives the hunter very useful tools intended to bring about successful hunts with clean and efficient harvests. Through the use of these straightforward and easy-to-follow instructions, it is sincerely hoped that all hunters will find their skills improved and their hunts more successful.

Boone and Crockett Club<sup>®</sup> is a registered trademark of the Boone and Crockett Club, and is used with their expressed written permission.

# An Overview of the Leupold Ballistics Aiming System®

The Leupold Ballistics Aiming System® provides a series of aiming points to improve your ability to shoot accurately at longer ranges. The first aiming point (the intersection of the Duplex® reticle) is designed to be used at 200 yards with most common cartridges or at 300 yards in several flatter shooting cartridges designed for longer range use.

The Leupold Ballistics Aiming System provides you with two different power selector positions, indicated by large and small triangles located within the magnification level indicators *on the power selector ring (VX-6, VX-3/3L models)*. These are provided to allow you to select the hold points best suited to the cartridge you are using. In some cases, the smaller triangle setting can be used to accommodate your slower, heavier bullet load, while the larger triangle can be used to accommodate a faster, lighter bullet load in the same rifle. The reticle assumes bullets of similar spitzer shape will be used throughout.

As an example, a .30-06 with a 180 gr. spitzer bullet and 2700 fps muzzle velocity would require the use of the smaller triangle mark. A .30-06 with a 150 gr. spitzer bullet at 3000 fps muzzle velocity would use the larger triangle mark. We have designated three sets of cartridges to be used in conjunction with the large and small triangles and sight-in distances of either 200 or 300 yards, described as Group A, Group B, and Group C:

- Group A cartridges will use the large triangle and a 200 yard zero
- Group B cartridges will use the small triangle and a 200 yard zero
- Group C cartridges will use the large triangle and a 300 yard zero

Be sure to verify the aiming points by practicing at the actual distances at which the points are intended to work. Ballistics performance of your rifle and cartridge can vary somewhat from ammunition manufacturer data due to rifle barrel length, actual ammunition performance, and various atmospheric conditions.

## Boone and Crockett™ Big Game Reticle Cartridge List

GROUP A (Large Triangle, 200 yard zero)		
Caliber	Bullet Wt.	Velocity
.223 Remington	40	3800 fps
.22-250 Remington	55	3650 fps
.243 Winchester	100	2900 fps
.25-06 Remington	100	3200 fps
.25-06 Remington	120	3000 fps
.270 Winchester	130	3050 fps
.270 WSM	150	3120 fps
.280 Remington	140	3000 fps
7mm Remington Mag	150	3050 fps
.30-06 Springfield	150	3000 fps
.300 WBY Mag	180	3100 fps
.300 Winchester Mag	180	2950 fps
.300 WSM	180	2950 fps
.338 Winchester Mag	200	2950 fps
.338 RUM	250	2900 fps

(35-45 inches of drop at 500 yards)

GROUP B (Small Triangle, 200 yard zero)		
Caliber	Bullet Wt.	Velocity
.260 Remington	120	2850 fps
6.5x55 Swedish	129	2750 fps
.30-06 Springfield	180	2700 fps
.308 Winchester	150	2850 fps
.308 Winchester	165	2700 fps
.303 British	150	2700 fps
.270 Winchester	150	2850 fps
.375 H&H	270	2700 fps
.338 Winchester Mag	225	2800 fps
.338 Winchester Mag	250	2700 fps
.375 H&H	300	2600 fps

(48-58 inches of drop at 500 yards)

GROUP C (Large Triangle, 300 yard zero)		
Caliber	Bullet Wt.	Velocity
.270 WSM	130	3275 fps
.300 WSM	150	3300 fps
.300 Winchester Mag	150	3300 fps
7mm WSM	140	3225 fps
7mm STW	140	3325 fps
7mm RUM	140	3450 fps
7mm RUM	160	3250 fps
.30-.378 WBY	180	3400 fps
.300 RUM	180	3400 fps
.270 Weatherby	130	3200 fps
7mm Remington Mag	150	3100 fps
.300 WBY Mag	150	3375 fps

(Less than 35 inches of drop at 500 yards)

# General Instructions For the Use of the Leupold Ballistics Aiming System

## SIGHTING-IN

The Boone and Crockett Big Game reticle is sighted-in by zeroing the rifle at the intersection of the Duplex reticle at either 200 yards (Group A and B), or 300 yards (Group C). For Group C cartridges sighted-in at 300 yards, the lower aiming marks will be correct at 400, 500, 550, and 600 yards. The scope must then be set to the appropriate triangle to properly use the ballistics compensation features. Be sure to verify the aiming points by practicing at the actual distances at which the points are intended to work. Ballistics performance of your rifle and cartridge can vary somewhat from ammunition manufacturer data due to rifle barrel length, actual ammunition performance, and various atmospheric conditions. See the Rifle Scope Owner's Handbook for detailed sighting-in instructions.

# Boone and Crockett™ Big Game Reticle Features

The Boone and Crockett Big Game reticle offers:

- a Duplex central aiming point (sighted-in at 200 or 300 yards) as well as CPC-style hold points calibrated to 300 and 400 yards, and additional aiming features for targets at 450 and 500 yards for Group A and Group B cartridges (add 100 yards for Group C cartridges)
- a 10 mph windage hold point at both the left and right ends of the 300 and 400 yard CPC-style hold points
- the traditional VX®-3/3L range estimating feature between the Duplex central aiming point and the top vertical heavy post (consult the Leupold Riflelescope Owner's Manual)





**BOONE AND CROCKETT CLUB**  
Fair Chase and Conservation  
SINCE 1887

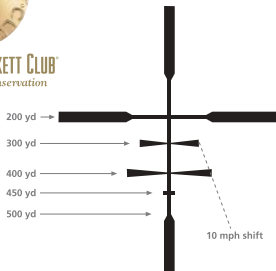

Range	Power Selector Values		10 MPH Drift
	Large ▼ Bullet Drop	Small ▼ Bullet Drop	
200 yd MOA	—	—	—
200 yd Inches	—	—	—
300 yd MOA	2.19	2.74	2.16
300 yd Inches	6.88	8.61	6.79
400 yd MOA	4.80	6.00	3.03
400 yd Inches	20.11	25.13	12.69
450 yd MOA	6.26	7.83	—
450 yd Inches	29.50	36.87	—
500 yd MOA	7.82	9.78	—
500 yd Inches	40.95	51.18	—

**NOTE:** *When using a cartridge in Group C and sighting-in at 300 yards, add 100 yards to all of the above yardage indicators.*

# Using the Boone and Crockett™ Big Game Reticle

In order to use the Boone and Crockett Big Game reticle, you must determine which of the three groups (Group A, Group B, or Group C) your cartridge and load fits into.

## DETERMINE POWER SELECTOR SETTING

First, determine which of the triangles on the power selector is the correct one to use with your particular rifle caliber, bullet weight, and muzzle velocity. Refer to the tables of Group A, Group B, and Group C cartridges on page 4.

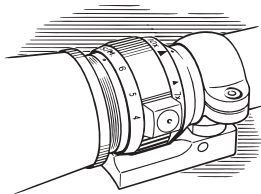

Once you have determined which triangle is the correct one for your rifle caliber, bullet weight, and muzzle velocity, always remember that is the position to which you must set the power selector when using any of the hold points on the Boone and Crockett Big Game reticle.

## DETERMINE THE RANGE TO THE TARGET

Determine the range to your target using a laser rangefinder such as a Leupold Series digital laser rangefinder, or utilize the traditional VX-3/3L range estimating feature using the space between the Duplex central aiming point and the top vertical heavy post. For more information about how to use this feature, consult your Leupold Riflescope Owner's Manual.

## AIMING

The Boone and Crockett Big Game reticle is a hold point reticle. For targets judged to be 300 yards away, hold directly on the 300 yard hold point. For 350 yard targets, hold directly between the 300 and 400 yard hold points. For your convenience, a 450 yard hold point has been included between the 400 and 500 yard hold points.

## WIND COMPENSATION

The left and right edges of the 300 and 400 yard hold points may be used as 10 mph wind compensators. To correct for a wind speed of 10 mph, place the edge of the hold point for the appropriate distance directly on the target when aiming.

## CONCLUSION

- Choose the appropriate ballistics group
- Sight-in at the distance required by that group (this may be done at any magnification setting)
- Adjust the magnification to the appropriate triangle before using any of the long range hold or windage points

# The Leupold Ballistics Aiming System — Varmint Hunter's™ Reticle

The goal of every hunter is a successful hunt with a cleanly made harvest. Whether a hunter is pursuing big game or varmints, it is imperative that he or she strive to make a quick, humane kill. It is with this in mind that Leupold has introduced the Varmint Hunter's™ reticle, a tool intended to allow shooters to make solid hits and clean kills at longer ranges on varmints.

The Varmint Hunter's reticle gives the hunter very useful tools intended to bring about successful hunts with clean and efficient harvests. Through the use of these straightforward and easy-to-follow instructions, it is sincerely hoped that all hunters will find their skills improved and their hunts more successful.

# An Overview of the Leupold Ballistics Aiming System®

The Leupold Ballistics Aiming System® provides a series of aiming points to improve your ability to shoot accurately at longer ranges. The first aiming point (the intersection of the German #4 reticle) is designed to be used at 200 yards with most common varmint cartridges or at 300 yards in several flatter shooting cartridges designed for longer range use. See page 14 for cartridge group tables.

The Leupold Ballistics Aiming System provides you with two different power selector positions, indicated by large and small triangles located within the magnification level indicators *on the power selector ring (VX-6, VX-3/3L models)*. These are provided to allow you to select the hold points best suited to the cartridge you are using. In some cases, the smaller triangle setting can be used to accommodate your slower, heavier bullet load, while the larger triangle can be used to accommodate a faster, lighter bullet load in the same rifle. The reticle assumes bullets of similar spitzer shape will be used throughout.

As an example, a .223 Remington with a 40 gr. V-max® bullet and 3800 fps muzzle velocity would require the use of the larger triangle mark. A .223 Remington with a 55 gr. V-max bullet at 3240 fps muzzle velocity would use the smaller triangle mark. We have designated three sets of cartridges to be used in conjunction with the large and small triangles and sight-in distances of 200 yards, described as Group A, Group B, and Group C.

- Group A cartridges will use the large triangle and a 200 yard zero
- Group B cartridges will use the small triangle and a 200 yard zero
- Group C cartridges will use the large triangle and a 300 yard zero

## Varmint Hunter's™ Reticle Cartridge List

GROUP A (Large Triangle, 200 yard zero)		
Caliber	Bullet Wt.	Velocity
.17 Remington	25	4000 fps
.223 Remington	40	3800 fps
.222 Remington	40	3600 fps
.22-250 Remington	50	3800 fps
.22-250 Remington	55	3680 fps
.220 Swift	50	3850 fps
.220 Swift	50	3750 fps
.220 Swift	55	3680 fps
.223 WSSM	55	3850 fps
.243 Winchester	58	3750 fps
.25-06 Remington	100	3200 fps
.25-06 Remington	120	3000 fps
.270 Winchester	130	3050 fps
.270 WSM	130	3200 fps
.270 Weatherby	130	3200 fps
7mm Remington Mag	150	3100 fps
.300 Winchester Mag	180	3100 fps

(30-40 inches of drop at 500 yards)

GROUP B (Small Triangle, 200 yard zero)		
Caliber	Bullet Wt.	Velocity
.222 Remington	50	3150 fps
.223 Remington	53	3300 fps
.222 Remington Mag	55	3250 fps
.223 Remington	55	3250 fps
.243 Winchester	75	3400 fps
.243 Winchester	100	2900 fps
6mm Remington	75	3400 fps
.257 Roberts	117	2900 fps
.270 Winchester	150	2850 fps
7mm Remington Mag	175	2850 fps

(45-55 inches of drop at 500 yards)

GROUP C (Large Triangle, 300 yard zero)		
Caliber	Bullet Wt.	Velocity
.17 Remington	20	4250 fps
.204 Ruger	32	4225 fps
.204 Ruger	40	3900 fps
.220 Swift	40	4200 fps
.22-250 Remington	40	4150 fps
.243 Winchester	55	3900 fps
.243 WSSM	55	4050 fps
.7mm STW	140	3325 fps
.7mm RUM	140	3450 fps
.7mm RUM	160	3250 fps
.30-.378 WBY	180	3400 fps
.300 RUM	180	3400 fps

(Less than 30 inches of drop at 500 yards)



# General Instructions For the Use of the Leupold Ballistics Aiming System®

## SIGHTING-IN

The Varmint Hunter's™ and LR Varmint Hunter's reticles are sighted-in by zeroing the rifle at the intersection of the German #4 reticle at 200 yards for cartridge Groups A and B, and at 300 yards for Group C. Groups A and B will then have 300, 400, and 500 yard aiming points, while Group C will have 400, 500 and 600 yard aiming points. The LR Varmint Hunter's reticle has an additional 100 yard aiming point yielding a 600 yard holdover for Groups A and B, and a 700 yard holdover for Group C cartridges. The scope must then be set to the appropriate triangle to properly use the ballistics compensation features. Be sure to verify the aiming points by practicing at the actual distances at which the points are intended to work. Ballistics performance of your rifle and cartridge can vary somewhat from ammunition manufacturer data due to rifle barrel length, actual ammunition performance, and various atmospheric conditions.

# Varmint Hunter's™ Reticle Features

The Varmint Hunter's reticle offers:

- a fine-lined German #4-style central aiming point (sighted-in at 200 yards in most cases) as well as cross-wire aiming points calibrated to 300, 400, 500 and 600 yards (LR Varmint Hunter's)
- 10 and 20 mph windage hold points at both the left and right ends of the 300, 400, 500 and 600 yard cross-wire hold points
- 10 and 20 mph windage hold points along the German #4-style central aiming point line
- a prairie dog range estimator between the lowest aiming point and bottom vertical heavy post

## Varmint Hunter's™ Reticle

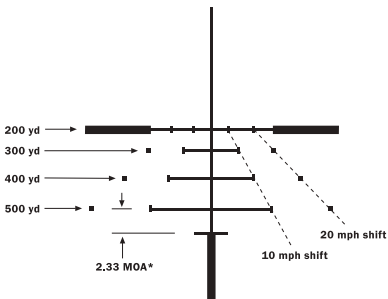

Range	Power Selector Values		10 MPH Drift	20 MPH Drift	10 MPH Drift	20 MPH Drift
	Large ▼ Bullet Drop	Small ▼ Bullet Drop	Large	Large	Small	Small
200 yd MOA	—	—	1.77	3.54	2.21	4.43
200 yd Inches	—	—	3.71	7.41	4.63	9.28
300 yd MOA	1.81	2.26	2.86	5.72	3.58	7.16
300 yd Inches	5.69	7.10	8.98	17.97	11.24	22.49
400 yd MOA	4.13	5.16	4.09	8.17	5.11	10.22
400 yd Inches	17.30	21.61	17.13	34.22	21.4	42.8
500 yd MOA	7.02	8.78	5.49	10.99	6.87	13.75
500 yd Inches	36.80	46.00	25.87	51.79	35.96	71.98
600 yd MOA (LR Varmint Hunter)	10.63	13.3	7.32	14.64	9.16	18.31
600 yd Inches (LR Varmint Hunter)	66.78	83.55	45.98	91.97	57.54	115.02

\*Brackets a standing prairie dog at 300 yards. If the prairie dog is smaller than the bracket, then it is more than 300 yards away.

# LR Varmint Hunter's™ Reticle

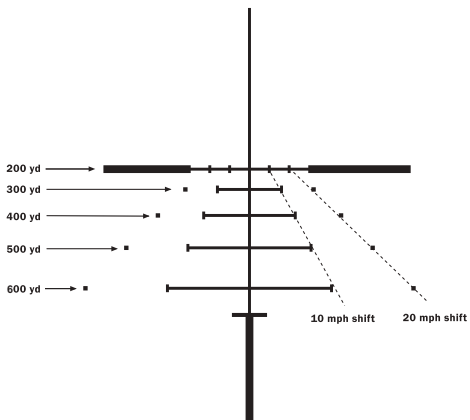

## Using the Varmint Hunter's Reticle

In order to use the Varmint Hunter's reticle, you must determine which of the three groups (Group A, Group B, or Group C) your cartridge and load fits into.

### DETERMINE POWER SELECTOR SETTING

First, determine which of the triangles on the power selector is correct for your particular rifle caliber, bullet weight, and muzzle velocity. Refer to the tables of Group A, Group B, and Group C cartridges on page 14.

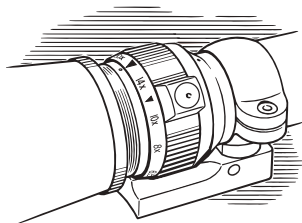

Once you have determined which triangle is the correct one for your rifle caliber, bullet weight, and muzzle velocity, always remember that is the position to which you must set the power selector when using any of the hold points on the Varmint Hunter's reticle.

## DETERMINE THE RANGE TO THE TARGET

Determine the range to your target using a laser rangefinder such as a Leupold RX Series digital laser rangefinder. Or you may determine whether a prairie dog-sized target is 300 yards or closer by setting the power selector on the large triangle and fitting the target in the space between the top of the bottom post and the 500 yard aiming line. If the target is larger than this space, it is closer than 300 yards. If it is smaller, then it is farther than 300 yards.

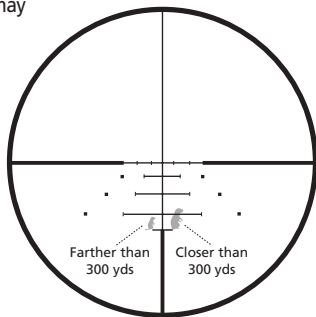

**NOTE:** You must have your power selector ring positioned on the large triangle to make a proper determination of range.

## AIMING

The Varmint Hunter's reticle is a hold point reticle. For targets judged to be 300 yards away, hold directly on the 300 yard hold point. For 350 yard targets, hold directly between the 300 and 400 yard hold points, for 450 yard targets hold directly between the 400 and 500 yard hold points.

## WIND COMPENSATION

The left and right edges of the 300, 400, and 500 yard hold points may be used as 10 mph wind compensators. To correct for a wind speed of 10 mph, place the edge of the hold point for the distance of the target directly on the target when aiming. To correct for a 20 mph wind, place the small square to the right or left of the appropriate 10 mph hold point directly on the target when aiming.

## CONCLUSION

- Choose the appropriate ballistics group
- Sight-in at the distance required by that group (this may be done at any magnification setting)
- Adjust the magnification to the appropriate triangle before using any of the long range hold or windage points

# The Leupold Ballistics Aiming System — LR Duplex<sup>®</sup> Reticle

To use the LR Duplex reticle, zero your rifle at either 200 yards for Group A cartridges or at 300 yards if your rifle is chambered for one of the Group C cartridges from the LR Duplex table on page 23. If you are using a Group A cartridge, this will make the dots below the horizontal crosswire be zeroed for 300, 400, and 500 yards. If you are using a Group C cartridge, this will make the dots below the crosswire be zeroed for 400, 500, and 600 yards. The scope must then be set to its highest magnification setting to properly use the ballistics compensation features.



## LR Duplex Reticle Cartridge List

GROUP A (High Magnification, 200 yard zero)		
Caliber	Bullet Wt.	Velocity
.223 Remington	40	3800 fps
.22-250 Remington	55	3650 fps
.243 Winchester	100	2900 fps
.25-06 Remington	100	3200 fps
.25-06 Remington	120	3000 fps
.270 Winchester	130	3050 fps
.270 WSM	150	3120 fps
.280 Remington	140	3000 fps
7mm Remington Mag	150	3050 fps
.30-06 Springfield	150	3000 fps
.300 WBY Mag	180	3100 fps
.300 Winchester Mag	180	2950 fps
.300 WSM	180	2950 fps
.338 Winchester Mag	200	2950 fps
.338 RUM	250	2900 fps

(35-45 inches of drop at 500 yards)

GROUP C (High Magnification, 300 yard zero)		
Caliber	Bullet Wt.	Velocity
.270 WSM	130	3275 fps
.300 WSM	150	3300 fps
.300 Winchester Mag	150	3300 fps
7mm WSM	140	3225 fps
7mm STW	140	3325 fps
7mm RUM	140	3450 fps
7mm RUM	160	3250 fps
.30-.378 WBY	180	3400 fps
.300 RUM	180	3400 fps
.270 Weatherby	130	3200 fps
7mm Remington Mag	150	3100 fps
.300 WBY Mag	150	3375 fps

(Less than 35 inches of drop at 500 yards)

## LR Duplex Reticle 2-7x Models

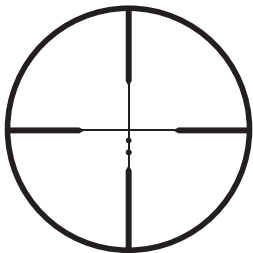

Reticle Feature	MOA @ High X	MOA @ Low X
Fine Line Width (Line Width)	0.41	1.08
Heavy Line Width (Thick Section)	1.26	3.32
Picket to Picket Space (Thin Opening)	19.77	52.13
Dot Diameter	1.24	3.27
300 Yard Dot (Distance from Center)	2.19	5.77
400 Yard Dot (Distance from Center)	4.80	12.66
Center to Bottom Picket Tip Spacing (500 Yards)	7.82	20.62

## LR Duplex Reticle 3-9x Models

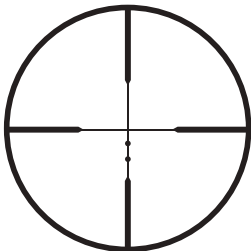

Reticle Feature	MOA @ High X	MOA @ Low X
Fine Line Width (Line Width)	0.32	0.84
Heavy Line Width (Thick Section)	0.97	2.56
Picket to Picket Space (Thin Opening)	15.24	40.19
Dot Diameter	0.95	2.51
300 Yard Dot (Distance from Center)	2.19	5.77
400 Yard Dot (Distance from Center)	4.80	12.66
Center to Bottom Picket Tip Spacing (500 Yards)	7.82	20.62

## LR Duplex 4-12x Models

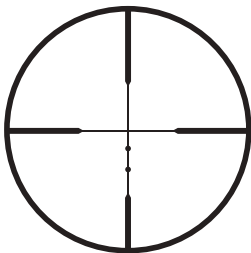

Reticle Feature	MOA @ High X	MOA @ Low X
Fine Line Width (Line Width)	0.24	0.63
Heavy Line Width (Thick Section)	0.72	1.90
Picket to Picket Space (Thin Opening)	11.32	29.85
Dot Diameter	0.71	1.87
300 Yard Dot (Distance from Center)	2.19	5.77
400 Yard Dot (Distance from Center)	4.80	12.66
Center to Bottom Picket Tip Spacing (500 Yards)	7.82	20.62

## FireDot® LR Duplex 2-12x Models

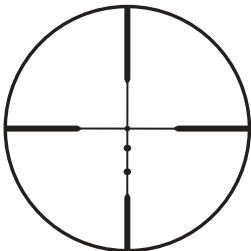

Reticle Feature	MOA @ High X	MOA @ Low X
Fine Line Width (Line Width)	0.4	2.10
Heavy Line Width (Thick Section)	0.9	5.25
Picket to Picket Space (Thin Opening)	15.28	91.67
Dot Diameter	1.0	6.3
300 Yard Dot (Distance from Center)	2.19	13.14
400 Yard Dot (Distance from Center)	4.80	28.80
Center to Bottom Picket Tip Spacing (500 Yards)	7.82	46.92

## CONCLUSION

- Choose the appropriate ballistics group
- Sight-in at the distance required by that group (this may be done at any magnification setting)
- Adjust the magnification to the highest setting before using any of the long range hold points

## The Leupold Ballistics Aiming System — LRV Duplex® Reticle

To use the LRV Duplex reticle, zero your rifle at either 200 yards (Group A cartridges from the LRV Duplex table on page 30) or 300 yards (Group C cartridges from the LRV Duplex table on page 30). This will zero the hash marks below the horizontal crosswire at either 300, 400 and 500 yards in the case of Group A cartridges, or 400, 500 and 600 yards in the case of Group C cartridges. Similarly, as in the case of the LR Duplex, the scope must be set to its highest magnification level in order to properly use the ballistics compensating features.

## LRV Duplex Reticle Cartridge List

<b>GROUP A</b> (High Magnification, 200 yard zero)		
Caliber	Bullet Wt.	Velocity
.222 Remington	50	3150 fps
.223 Remington	53	3300 fps
.222 Remington Mag	55	3250 fps
.223 Remington	55	3250 fps
.243 Winchester	75	3400 fps
.243 Winchester	100	2900 fps
6mm Remington	75	3400 fps
.257 Roberts	117	2900 fps
.270 Winchester	150	2850 fps
7mm Remington Mag	175	2850 fps

(45-55 inches of drop at 500 yards)

<b>GROUP C</b> (High Magnification, 300 yard zero)		
Caliber	Bullet Wt.	Velocity
.17 Remington	20	4250 fps
.204 Ruger	32	4225 fps
.204 Ruger	40	3900 fps
.220 Swift	40	4200 fps
.22-250 Remington	40	4150 fps
.243 Winchester	55	3900 fps
.243 WSSM	55	4050 fps
.7mm STW	140	3325 fps
.7mm RUM	140	3450 fps
.7mm RUM	160	3250 fps
.30-.378 WBY	180	3400 fps
.300 RUM	180	3400 fps

(Less than 30 inches of drop at 500 yards)



## LRV Duplex Reticle 6-18x Models

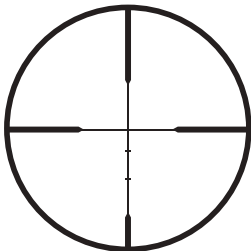

Reticle Feature	MOA @ High X	MOA @ Low X
Fine Line Width (Line Width)	0.16	0.42
Heavy Line Width (Thick Section)	0.49	1.29
Picket to Picket Space (Thin Opening)	7.63	20.12
300 Yard Hash (Distance from Center)	1.81	4.77
400 Yard Hash (Distance from Center)	4.13	10.89
Center to Bottom Picket Tip Spacing (500 Yards)	7.02	18.51

## CONCLUSION

- Choose the appropriate ballistics group
- Sight-in at the distance required by that group (this may be done at any magnification setting)
- Adjust the magnification to the highest setting before using any of the long range hold points

---

## Another Way to Sight-In

For use with the Boone & Crockett Big Game, Varmint Hunter's, LR Duplex, FireDot LR Duplex, Ballistic FireDot and LRV Duplex reticles. If you are using a LR Duplex or LRV Duplex reticle with a cartridge from the Group B cartridge chart, or if you have a cartridge that does not appear in one of the accompanying cartridge charts, the following method will provide you with a quick and easy way to sight-in.

1. Initially, sight-in at 200 yards. Your point of impact needs to match your point of aim exactly at the 200 yard intersection of the reticle.
2. Using a larger target, place the target at a 500 yard distance and shoot a group while aiming with the 200 yard intersection; your bullets will strike significantly (in some instances 60 inches or more) below the center.

3. Using a black marker, circle the group of bullet holes and fill in the circle. This will create a large black dot representing the bullet impact on the target that should be visible from the firing line.
4. While maintaining the same point of aim (hold in the center of the target with the 200 yard intersection) adjust the magnification setting until the 500 yard holdover mark points to the middle of the large black dot created with the black marker. This will create a situation where the scope is dead on at 200 yards and at 500 yards. Any variances at 300, 400, and 450 will be quite negligible.

In order to use any of the hold points accurately, the scope will need to be used on the exact magnification used to align the 500 yard mark with the center of the black dot. For best results, check all aiming points at the actual distances for which they are intended.

# The Leupold Ballistics Aiming System — SAbot Ballistics Reticle® (SA.B.R.®)

The goal of every hunter is a successful hunt with a cleanly made harvest. Whether a hunter is pursuing big game or varmints, it is imperative that he or she strive to make a quick, humane kill. It is with this in mind that Leupold has introduced the SAbot Ballistics Reticle, a tool intended to allow muzzleloader and shotgun shooters to make solid hits and clean kills at longer ranges.

The SAbot Ballistics Reticle reticles give hunters a series of very useful tools intended to bring about successful hunts with clean and efficient harvests. Through the use of these straightforward and easy-to-follow instructions, it is sincerely hoped that all hunters will find their skills improved and their hunts more successful.

## An Overview of the Leupold Ballistics Aiming System<sup>®</sup> — SAbot Ballistics Reticle (SA.B.R.)

The Leupold SAbot Ballistics Reticle provides a series of aiming points to improve your ability to shoot accurately at longer ranges. The first aiming point (the intersection of the Circle-Plex style reticle) is designed to be used at 100 yards. The Leupold SAbot Ballistics Reticle provides you with three different power selector positions, indicated by 2 pellets, 3 pellets, and a shotgun shell within the magnification level indicators. These are provided to allow you to select the hold points best suited to the load you are using. The reticle assumes polymer-tipped sabots will be used throughout. As an example, a .50 caliber sabot with a 250 gr., .45 caliber Hornady SST/ML bullet exiting the muzzle at 2200 fps (3 pellets/150 grains of powder) would require the use of the 3 pellets setting. The same sabot/bullet combination with a muzzle velocity of 1890 fps (2 pellets/100 grains of powder) would require the use of the 2 pellets setting. 12-gauge shotgun applications would use the shotgun shell setting, a 350 gr. Hornady FPB at 1950 fps is ideally suited for use on the 12-gauge setting, and 20-gauge shotgun loads would use the 2 pellets muzzleloader setting.

# General Instructions For the Use of the Leupold Ballistics Aiming System®

## SIGHTING-IN

The Sabot Ballistics Reticle (SA.B.R.) is sighted-in at 100 yards (this may be done at any magnification setting) by zeroing the muzzleloader or shotgun at the intersection of the Circle-Plex style reticle at 100 yards. The scope must then be set to the appropriate magnification to properly use the ballistics compensation features. The top and bottom of the circle will be aim points for 50 yard and 150 yard targets respectively. The lower aiming dots will be correct at 200 and 250 yards, and the top of the bottom picket will be the proper aim point for 300 yard shots.

Shooting at extended ranges using a muzzleloader or shotgun should only be performed under controlled circumstances. Be sure to verify the aiming points by practicing at the actual distances at which the points are intended to work. Ballistic performance of your projectile can vary somewhat from component manufacturer data due to barrel length, actual component performance, and various atmospheric conditions.

# SAbot Ballistics Reticle Features

- A distinct Circle-Plex style central aiming point (sighted-in at 100 yards) as well as hold points calibrated to 50, 150, 200, 250, and 300 yards for most loads
- Precise aiming dots designed to step-down in size to subtend 3 MOA at the intended distances
- A White-tailed deer range estimator

The S.A.B.R.<sup>®</sup> provides accurate hold points for long range targets; shooting at extended distances with a shotgun or muzzleloader may not be practical or ethical in all situations. As with any shooting related activity, caution and good judgement should be exercised at all times.

## SAbot Ballistics Reticle (SA.B.R.) 2-7x Models

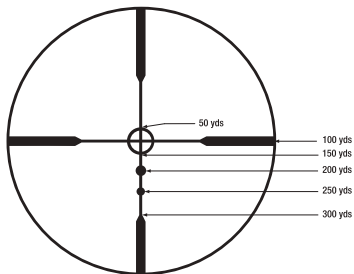

Reticle Feature (MOA)	3 Pellet (High Power)	12 Gauge Shotgun	2 Pellet/ 20 Gauge Shotgun	Low Power
Fine Line Thickness	0.41	0.49	0.61	1.08
Heavy Line Thickness	1.25	1.50	1.87	3.33
Center to Top, Left, Right Thin Opening	8.00	9.58	11.93	21.23
150 Yard Feature (Bottom of Circle)	1.84	2.20	2.75	4.89
200 Yard Feature	4.00	4.79	5.97	10.61
250 Yard Feature	6.80	8.14	10.14	18.04
300 Yard Feature Thin Opening	10.00	11.97	14.92	26.53
Inside Circle Diameter	2.86	3.43	4.27	7.60
200 Yard Dot Diameter	1.43	1.71	2.14	3.80
250 Yard Dot Diameter	1.14	1.37	1.71	3.04



## SAbot Ballistics Reticle (SA.B.R.) 3-9x Models

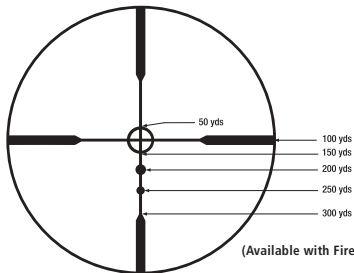

(Available with FireDot-R SA.B.R. Reticle)



Reticle Feature (MOA)	3 Pellet (High Power)	12 Gauge Shotgun	2 Pellet/ 20 Gauge Shotgun	Low Power
Fine Line Thickness	0.32	0.38	0.47	0.84
Heavy Line Thickness	0.97	1.17	1.45	2.57
Center to Top, Left, Right Thin Opening	8.00	9.58	11.93	21.07
150 Yard Feature (Bottom of Circle)	1.75	2.10	2.61	4.61
200 Yard Feature	4.00	4.79	5.97	10.54
250 Yard Feature	6.80	8.14	10.14	17.91
300 Yard Feature Thin Opening	10.00	11.97	14.92	26.34
Inside Circle Diameter	2.86	3.43	4.27	7.55
200 Yard Dot Diameter	1.43	1.71	2.14	3.77
250 Yard Dot Diameter	1.14	1.37	1.71	3.02

# Using the SAbot Ballistics Reticle

First, determine which of the charge/ballistics settings on the power selector is the correct one to use based on your load.

1. Sight in at 100 yards on any magnification setting
2. Determine which charge/ballistics setting to use
3. Be sure to use this mark any time you want to use one of the aiming points below center

## DETERMINE POWER SELECTOR SETTING

First, determine which of the marks on the power selector is the correct one to use with your particular load. Once you have determined which mark is the correct one for your load, always remember that is the position to which you must set the power selector when using any of the hold points on the SA.B.R.

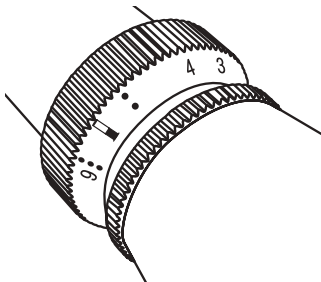

## DETERMINE THE RANGE TO THE TARGET

Determine the range to your target using a laser rangefinder such as a Leupold RX Series digital laser rangefinder. Or you may determine whether a mature whitetail-sized target is 200 yards or closer by setting the power selector to high magnification (3 pellets setting) and bracketing a mature whitetail between the horizontal crosswire and the bottom of the upper vertical picket.

If the buck is larger than this space, it is closer than 200 yards. If it's smaller than this space, then it's farther than 200 yards.

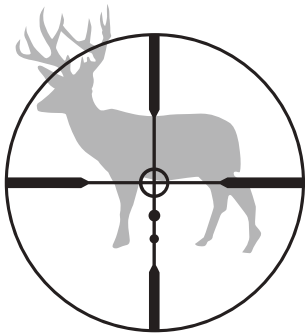

## AIMING

The SA.B.R. is a hold point reticle. For targets judged to be 200 yards away, hold directly on the 200 yard hold point. For 225 yard targets, hold directly between the 200 and 250 yard hold points.

## CONCLUSION

- Choose the appropriate load setting
- Sight-in at 100 yards (this may be done at any magnification setting)
- Adjust the magnification to the appropriate charge/ballistics setting before using any of the long range hold points

---

## Another Way to Sight-In (SA.B.R.)

For use with the SAbot Ballistics Reticle, if you are using a unique muzzleloader or shotgun load, the following method will provide you with a quick and easy way to sight-in.

1. Initially, sight-in at 100 yards. Your point of impact needs to match your point of aim exactly at the 100 yard intersection of the reticle.

2. Using a larger target, place the target at a 300 yard distance and shoot a group while aiming with the 100 yard intersection; your bullets will strike significantly (in some instances 60 inches or more) below the center.
3. Using a black marker, circle the group of bullet holes and fill in the circle. This will create a large black dot representing the bullet impact on the target that should be visible from the firing line.
4. While maintaining the same point of aim (hold in the center of the target with the 100 yard intersection) adjust the magnification setting until the 300 yard holdover mark points to the middle of the large black dot created with the black marker. This will create a situation where the scope is dead on at 100 yards and at 300 yards. Any variances at 150, 200, and 250 will be quite negligible.

In order to use any of the hold points accurately, the scope will need to be used on the exact magnification used to align the 300 yard mark with the center of the black dot. For best results, check all aiming points at the actual distances for which they are intended.

# The Leupold Ballistics Aiming System — Ballistic FireDot® Reticle

To use the Ballistic FireDot reticle, zero your rifle at either 200 yards (Group A cartridges) or 300 yards (Group C cartridges from the Ballistic FireDot table on page 45). This will zero the hash marks below the horizontal crosswire at either 300, 400 and 500 yards in the case of Group A cartridges, or 400, 500 and 600 yards in the case of Group C cartridges. Similarly, as in the case of the LR Duplex, the scope must be set to it's highest magnification level in order to properly use the ballistics compensating features.

## Ballistic FireDot Reticle Cartridge List

<b>GROUP A (High Magnification, 200 yard zero)</b>		
Caliber	Bullet Wt.	Velocity
.222 Remington	50	3150 fps
.223 Remington	53	3300 fps
.222 Remington Mag	55	3250 fps
.223 Remington	55	3250 fps
.243 Winchester	75	3400 fps
.243 Winchester	100	2900 fps
6mm Remington	75	3400 fps
.257 Roberts	117	2900 fps
.270 Winchester	150	2850 fps
7mm Remington Mag	175	2850 fps

(45-55 inches of drop at 500 yards)

<b>GROUP C (High Magnification, 300 yard zero)</b>		
Caliber	Bullet Wt.	Velocity
.17 Remington	20	4250 fps
.204 Ruger	32	4225 fps
.204 Ruger	40	3900 fps
.220 Swift	40	4200 fps
.22-250 Remington	40	4150 fps
.243 Winchester	55	3900 fps
.243 WSSM	55	4050 fps
.7mm STW	140	3325 fps
.7mm RUM	140	3450 fps
.7mm RUM	160	3250 fps
.30-.378 WBY	180	3400 fps
.300 RUM	180	3400 fps

(Less than 30 inches of drop at 500 yards)

## Ballistic FireDot Reticle 2-7x Models

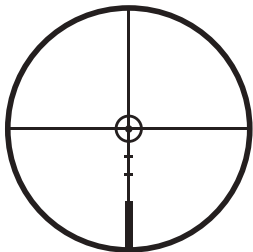

Reticle Feature		@ High X	@ Low X
Circle Inside	Inches/cm	4.6/12.8	11.5/31.9
	MOA	4.4	11.0
Circle Line Width	Inches/cm	0.5/1.4	1.2/3.3
	MOA	0.4	1.1
Dot	Inches/cm	1.0/2.8	2.5/6.9
	MOA	1.0	2.5
300	MOA	2.19	5.77
Yard Drop	Inches	6.90	—
400	MOA	4.80	12.66
Yard Drop	Inches	20.10	—
500	MOA	7.82	20.62
Yard Drop	Inches	41.00	—



## Ballistic FireDot Reticle 3-9x Models

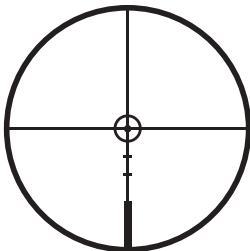

Reticle Feature		@ High X	@ Low X
Circle Inside	Inches/cm	4.6/12.8	11.5/31.9
	MOA	4.4	11.0
Circle	Inches/cm	0.4/1.1	0.9/2.5
Line Width	MOA	0.3	0.9
	Inches/cm	1.0/2.8	2.5/6.9
Dot	MOA	1.0	2.5
	MOA	2.19	5.77
300	MOA	6.90	—
Yard Drop	Inches	4.80	12.66
	MOA	20.10	—
400	MOA	7.82	20.62
Yard Drop	Inches	41.00	—
	MOA		

## Ballistic FireDot Reticle 4-12x Models

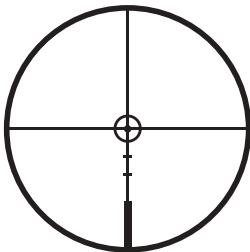

Reticle Feature		@ High X	@ Low X
Circle Inside	Inches/cm	4.6/12.8	11.5/31.9
	MOA	4.4	11.0
Circle	Inches/cm	0.3/0.8	0.7/1.9
	MOA	0.3	0.7
Line Width	Inches/cm	1.0/2.8	2.5/6.9
	MOA	1.0	2.5
300 Yard Drop	MOA	2.19	5.77
	Inches	6.90	—
400 Yard Drop	MOA	4.80	12.66
	Inches	20.10	—
500 Yard Drop	MOA	7.82	20.62
	Inches	41.00	—

## CONCLUSION

- Choose the appropriate ballistics group
- Sight-in at the distance required by that group (this may be done at any magnification setting)
- Adjust the magnification to the highest setting before using any of the long range hold points

---

## Another Way to Sight-In

For use with the Boone & Crockett Big Game, Varmint Hunter's, LR Duplex, FireDot LR Duplex, LRV Duplex, and Ballistic FireDot reticles. If you are using a LR Duplex or LRV Duplex reticle with a cartridge from the Group B cartridge chart, or if you have a cartridge that does not appear in one of the accompanying cartridge charts, the following method will provide you with a quick and easy way to sight-in.

1. Initially, sight-in at 200 yards. Your point of impact needs to match your point of aim exactly at the 200 yard intersection of the reticle.
2. Using a larger target, place the target at a 500 yard distance and shoot a group while aiming with the 200 yard intersection; your bullets will strike significantly (in some instances 60 inches or more) below the center.

3. Using a black marker, circle the group of bullet holes and fill in the circle. This will create a large black dot representing the bullet impact on the target that should be visible from the firing line.
4. While maintaining the same point of aim (hold in the center of the target with the 200 yard intersection) adjust the magnification setting until the 500 yard holdover mark points to the middle of the large black dot created with the black marker. This will create a situation where the scope is dead on at 200 yards and at 500 yards. Any variances at 300, 400, and 450 will be quite negligible.

In order to use any of the hold points accurately, the scope will need to be used on the exact magnification used to align the 500 yard mark with the center of the black dot. For best results, check all aiming points at the actual distances for which they are intended.

## The Leupold Ballistics Aiming System — Multi-FireDot™ Reticle

To use the Multi-FireDot reticle, zero your rifle at either 200 yards for Group A cartridges or at 300 yards if your rifle is chambered for one of the Group C cartridges from the Multi-FireDot table on page 52. If you are using a Group A cartridge, this will make the dots below the horizontal crosswire be zeroed for 300, 400, and 500 yards. If you are using a Group C cartridge, this will make the dots below the crosswire be zeroed for 400, 500, and 600 yards. The scope must then be set to its highest magnification setting to properly use the ballistics compensation features.

## Multi-FireDot Reticle Cartridge List

<b>GROUP A (High Magnification, 200 yard zero)</b>		
Caliber	Bullet Wt.	Velocity
.223 Remington	40	3800 fps
.22-250 Remington	55	3650 fps
.243 Winchester	100	2900 fps
.25-06 Remington	100	3200 fps
.25-06 Remington	120	3000 fps
.270 Winchester	130	3050 fps
.270 WSM	150	3120 fps
.280 Remington	140	3000 fps
7mm Remington Mag	150	3050 fps
.30-06 Springfield	150	3000 fps
.300 WBY Mag	180	3100 fps
.300 Winchester Mag	180	2950 fps
.300 WSM	180	2950 fps
.338 Winchester Mag	200	2950 fps
.338 RUM	250	2900 fps

(35-45 inches of drop at 500 yards)

<b>GROUP C (High Magnification, 300 yard zero)</b>		
Caliber	Bullet Wt.	Velocity
.270 WSM	130	3275 fps
.300 WSM	150	3300 fps
.300 Winchester Mag	150	3300 fps
7mm WSM	140	3225 fps
7mm STW	140	3325 fps
7mm RUM	140	3450 fps
7mm RUM	160	3250 fps
.30-.378 WBY	180	3400 fps
.300 RUM	180	3400 fps
.270 Weatherby	130	3200 fps
7mm Remington Mag	150	3100 fps
.300 WBY Mag	150	3375 fps

(Less than 35 inches of drop at 500 yards)

## Multi-FireDot Reticle 2-7x Models

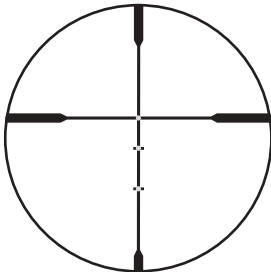

Reticle Feature	MOA @ High X	MOA @ Low X
Fine Line Width (3, 9 & 12 o'clock)	0.42	1.09
Fine Line Width (6 o'clock)	0.66	1.71
Heavy Line Width (Thick Section)	1.28	3.32
Picket to Picket Space (Thin Opening)	19.38	50.38
Dot Diameter	0.34	.88
Hash Length	1.28	3.32
300 Yard Hash (Distance from Center)	2.19	5.69
400 Yard Hash (Distance from Center)	4.80	12.48
Center to Bottom Picket Tip Spacing (500 Yards)	7.82	20.33

## Multi-FireDot Reticle 3-9x Models

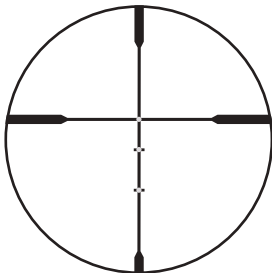

Reticle Feature	MOA @ High X	MOA @ Low X
Fine Line Width (3, 9 & 12 o'clock)	0.33	0.85
Fine Line Width (6 o'clock)	0.51	1.32
Heavy Line Width (Thick Section)	1.00	2.60
Picket to Picket Space (Thin Opening)	15.08	39.20
Dot Diameter	0.34	0.88
Hash Length	1.00	2.60
300 Yard Hash (Distance from Center)	2.19	5.69
400 Yard Hash (Distance from Center)	4.80	12.48
Center to Bottom Picket Tip Spacing (500 Yards)	7.82	20.33



## Multi-FireDot Reticle 4-12x Models

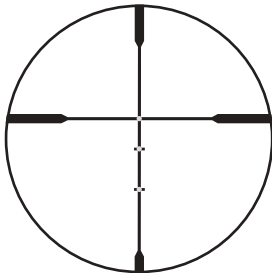

Reticle Feature	MOA @ High X	MOA @ Low X
Fine Line Width (3, 9 & 12 o'clock)	0.24	0.63
Fine Line Width (6 o'clock)	0.72	1.90
Picket to Picket Space (Thin Opening)	11.32	29.85
Dot Diameter	0.34	0.88
Hash Length	11.32	29.43
300 Yard Dot (Distance from Center)	2.19	5.77
400 Yard Dot (Distance from Center)	4.80	12.66
Center to Bottom Picket Tip Spacing (500 Yards)	7.82	20.62

## Multi-FireDot Reticle 2-12x Models

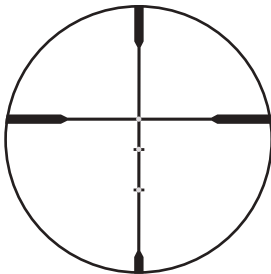

Reticle Feature	MOA @ High X	MOA @ Low X
Fine Line Width (3, 9 & 12 o'clock)	0.35	2.10
Fine Line Width (6 o'clock)	0.35	2.10
Heavy Line Width (Thick Section)	0.87	5.22
Picket to Picket Space (Thin Opening)	15.28	91.68
Dot Diameter	0.34	2.04
Hash Length	0.87	5.22
300 Yard Hash (Distance from Center)	2.19	13.14
400 Yard Hash (Distance from Center)	4.80	28.80
Center to Bottom Picket Tip Spacing (500 Yards)	7.82	46.92

## CONCLUSION

- Choose the appropriate ballistics group
- Sight-in at the distance required by that group (this may be done at any magnification setting)
- Adjust the magnification to the highest setting before using any of the long range hold points

---

## Another Way to Sight-In

For use with the Boone & Crockett Big Game, Varmint Hunter's, LR Duplex, FireDot LR Duplex, Ballistic FireDot and LRV Duplex reticles. If you are using a LR Duplex or LRV Duplex reticle with a cartridge from the Group B cartridge chart, or if you have a cartridge that does not appear in one of the accompanying cartridge charts, the following method will provide you with a quick and easy way to sight-in.

1. Initially, sight-in at 200 yards. Your point of impact needs to match your point of aim exactly at the 200 yard intersection of the reticle.

2. Using a larger target, place the target at a 500 yard distance and shoot a group while aiming with the 200 yard intersection; your bullets will strike significantly (in some instances 60 inches or more) below the center.
3. Using a black marker, circle the group of bullet holes and fill in the circle. This will create a large black dot representing the bullet impact on the target that should be visible from the firing line.
4. While maintaining the same point of aim (hold in the center of the target with the 200 yard intersection) adjust the magnification setting until the 500 yard holdover mark points to the middle of the large black dot created with the black marker. This will create a situation where the scope is dead on at 200 yards and at 500 yards. Any variances at 300, 400, and 450 will be quite negligible.

In order to use any of the hold points accurately, the scope will need to be used on the exact magnification used to align the 500 yard mark with the center of the black dot. For best results, check all aiming points at the actual distances for which they are intended.

# The Leupold Ballistics Aiming System — Pig-Plex® Ballistic Reticle

To use the Pig-Plex Ballistic Reticle, zero your rifle at either 200 yards for Group A cartridges or at 300 yards if your rifle is chambered for one of the Group C cartridges from the Pig-Plex Ballistic Reticle table below. If you are using a Group A cartridge, this will make the lower aiming marks below the horizontal crosswire be zeroed for 400, and 500 yards. If you are using a Group C cartridge, this will make the dots below the crosswire be zeroed for 400, 500, and 600 yards. The scope must then be set to its highest magnification setting to properly use the ballistics compensation features.

## Pig-Plex Ballistic Reticle Cartridge List

GROUP A (High Magnification, 200 yard zero)		
Caliber	Bullet Wt.	Velocity
.223 Remington	40	3800 fps
.22-250 Remington	55	3650 fps
.243 Winchester	100	2900 fps
.25-06 Remington	100	3200 fps
.25-06 Remington	120	3000 fps
.270 Winchester	130	3050 fps
.270 WSM	150	3120 fps
.280 Remington	140	3000 fps
7mm Remington Mag	150	3050 fps
.30-06 Springfield	150	3000 fps
.300 WBY Mag	180	3100 fps
.300 Winchester Mag	180	2950 fps
.300 WSM	180	2950 fps
.338 Winchester Mag	200	2950 fps
.338 RUM	250	2900 fps

(35-45 inches of drop at 500 yards)

GROUP C (High Magnification, 300 yard zero)		
Caliber	Bullet Wt.	Velocity
.270 WSM	130	3275 fps
.300 WSM	150	3300 fps
.300 Winchester Mag	150	3300 fps
7mm WSM	140	3225 fps
7mm STW	140	3325 fps
7mm RUM	140	3450 fps
7mm RUM	160	3250 fps
.30-.378 WBY	180	3400 fps
.300 RUM	180	3400 fps
.270 Weatherby	130	3200 fps
7mm Remington Mag	150	3100 fps
.300 WBY Mag	150	3375 fps

(Less than 35 inches of drop at 500 yards)

## Pig-Plex® Ballistic Reticle

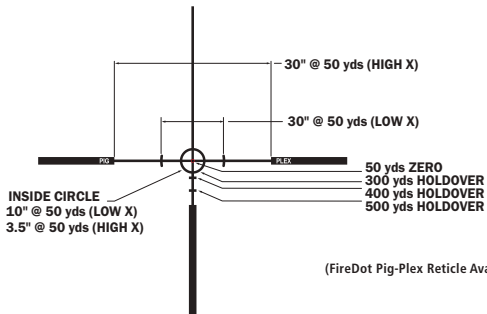

Reticle Feature	MOA @ High X	MOA @ Low X
Fine Line Width (Line Width)	0.9	2.3
Heavy Line Width (Thick Section)	8.8	23.4
Dot Diameter	0.95	2.5
Circle Diameter	7.3	19.3
300 Yard Holdover (From Center)	4.5	11.9
400 Yard Holdover	8.6	22.8
500 Yard Holdover	12.6	33.4
Center to Bottom Picket Tip Spacing	17.3	45.8

## CONCLUSION

- Choose the appropriate ballistics group
- Sight-in at the distance required by that group (this may be done at any magnification setting)
- Adjust the magnification to the highest setting before using any of the long range hold points

---

## Another Way to Sight-In

If you are using a Pig-Plex Ballistic Reticle with a cartridge that does not appear in one of the accompanying cartridge charts, the following method will provide you with a quick and easy way to sight-in.

1. Initially, sight-in at 200 yards. Your point of impact needs to match your point of aim exactly at the 200 yard intersection of the reticle.
2. Using a larger target, place the target at a 500 yard distance and shoot a group while aiming with the 200 yard intersection; your bullets will strike significantly (in some instances 60 inches or more) below the center.
3. Using a black marker, circle the group of bullet holes and fill in the circle. This will create a large black dot representing the bullet impact on the target that should be visible from the firing line.



4. While maintaining the same point of aim (hold in the center of the target with the 200 yard intersection) adjust the magnification setting until the 500 yard holdover mark points to the middle of the large black dot created with the black marker. This will create a situation where the scope is dead on at 200 yards and at 500 yards. Any variances at 300 or 400 will be quite negligible.

In order to use any of the hold points accurately, the scope will need to be used on the exact magnification used to align the 500 yard mark with the center of the black dot.

# The Leupold Ballistics Aiming System – TMOA™ & TMOA Plus Reticles

The TMOA and TMOA Plus reticles feature stadia lines on the horizontal and/or vertical crosshairs set at one minute of angle (MOA) increments, when set to high magnification. When used in conjunction with the Leupold RX-1000i or RX-1200i digital rangefinder set to MOA mode, these reticles allow the marksman to quickly holdover for bullet drop and windage correction. In addition, the intersection of the crosshair of the TMOA reticle is left open creating a small clear aperture for increased precision at longer ranges, while the TMOA Plus reticle features a precision aiming component with a opening that offers even more precise aiming capability (VX-6 7-42x56mm scopes only). Recent findings have determined that existing reticle designs obscure the target at longer distances. The TMOA reticles eliminate this problem.

The vertical and horizontal stadia lines can also be used for range estimation on objects of known size. To do this you can use the following formula:

(Target size in inches x 95.5 yards\*) / Measured MOA = Range in yards.

\* 1 inch = 1 MOA at 95.5 yards

## TMOA Reticle 4-24x Models

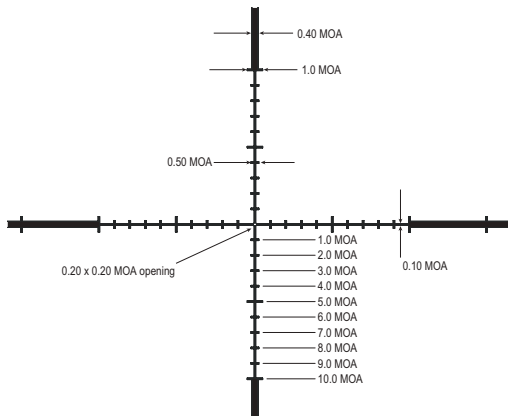

When ranging a deer that has a brisket to back measurement of 16 inches that brackets 4 MOA on the reticle, the formula would look like this:

$$(16 \times 95.5) / 4 = 382 \text{ yards}$$

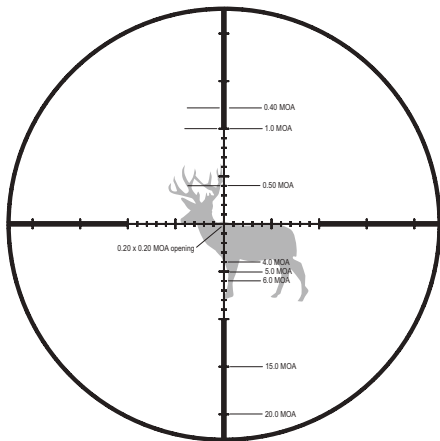

## TMOA Plus Reticle 7-42x Models

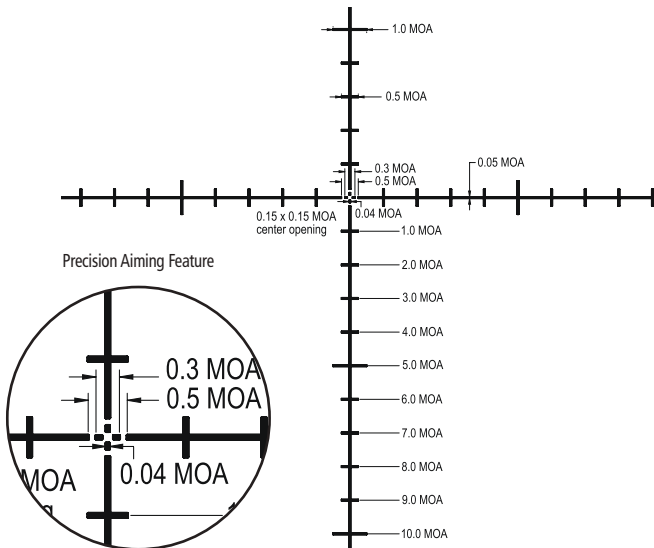

# Ballistics Aiming System® Development Team

Leupold & Stevens, Inc., worked with a diverse, highly skilled group of hunters and shooters to develop the new Ballistics Aiming System®, which includes the Boone and Crockett Big Game Reticle, the Varmint Hunter's Reticle, the LR Duplex Reticle, the LRV Duplex Reticle, and the SAbot Ballistics Reticle. Special thanks to: outdoor writer, ballistics consultant, and lifelong varmint hunter Steve Timm; the Boone and Crockett Club® staff; Tim Lesser, antelope, deer, elk, varmint guide, and valued employee of Leupold & Stevens, Inc. Again, thanks to each of you, and the entire Ballistics Aiming System development team, for your efforts. They have truly paid off.

*The Leupold package is made in part from recycled materials and is 100% recyclable. This includes the black polypropylene supports, which are made of an accepted recyclable material. Many Leupold owners keep their scope boxes. If you have no use for yours, we encourage you to dispose of it responsibly.*

LEUPOLD, GOLDEN RING, MARK 4, the Golden Ring design, the circle-L reticle logo design, and various other marks are registered trademarks of Leupold & Stevens, Inc. All marks, including corporate logos and emblems, are subject to Leupold's rights and may not be used in connection with any product or service that is not Leupold's, or in any manner that disparages or discredits Leupold, or in a manner likely to cause confusion.

Certain other trademarks used in connection with Leupold products and services are the property of their respective owners, and are used with permission. BOONE AND CROCKETT CLUB and BOONE AND CROCKETT are registered trademarks of the Boone and Crockett Club. NWTf is a registered trademark of the National Wild Turkey Federation. RMEF and ROCKY MOUNTAIN ELK FOUNDATION are registered trademarks of the Rocky Mountain Elk Foundation. MOSSY OAK BREAK-UP, MOSSY OAK BRUSH, MOSSY OAK OBSESSION, and MOSSY OAK TREESTAND are trademarks or registered trademarks of HAAS Outdoors, Inc. A.R.M.S. is a registered trademark of Atlantic Research Marketing Systems, Inc.

We reserve the right to make design and/or material modifications without prior notice.

Copyright © 2015 Leupold & Stevens, Inc. All rights reserved.

# Notes



# Notes

# Notes

# Notes



[www.leupold.com](http://www.leupold.com)

LEUPOLD+STEVENS INC.

P.O. BOX 688

BEAVERTON, OR 97075-0688 U.S.A.

1(800) LEUPOLD (538-7653)

14400 NW GREENBRIER PARKWAY

BEAVERTON, OR 97006-5790 U.S.A.

(503) 526-1400

Part # 55994 Artwork # 559930